

SKYLINE

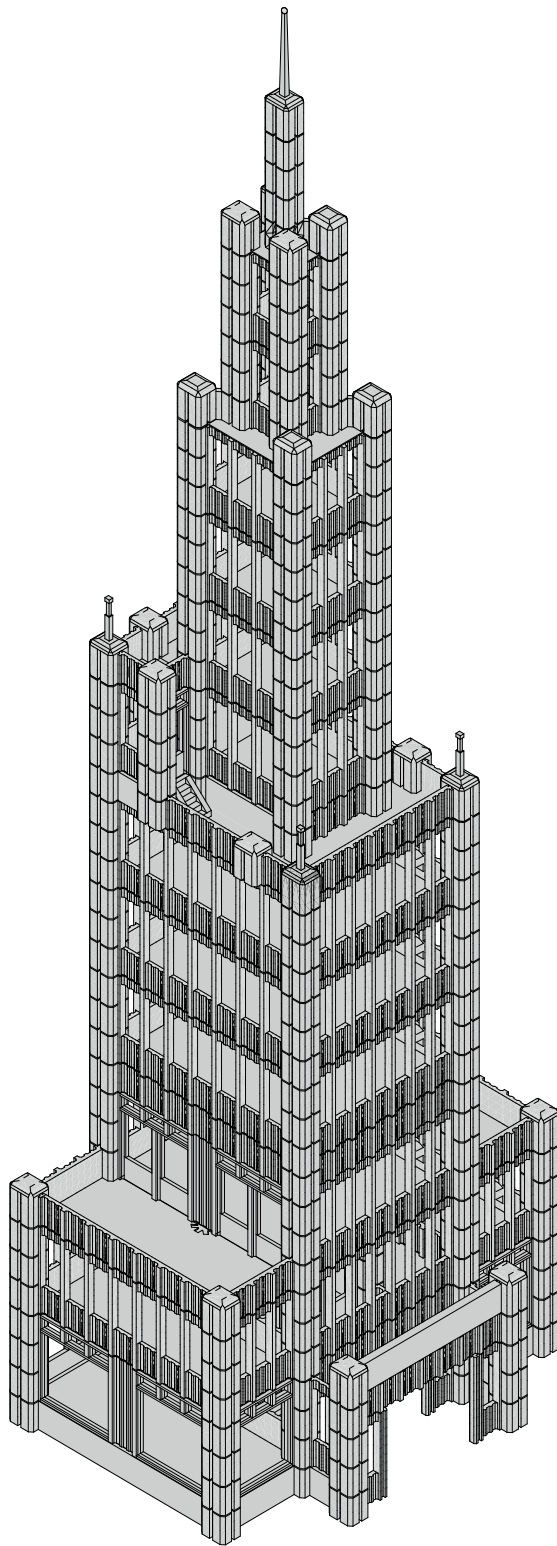

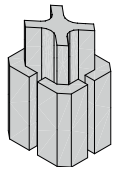

20x

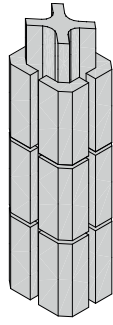

72x

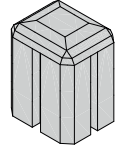

24x

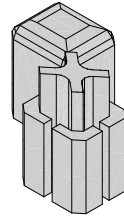

8x

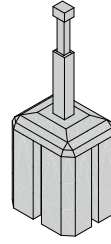

4x

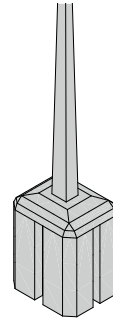

2x

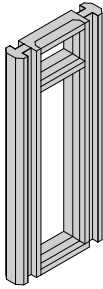

2x

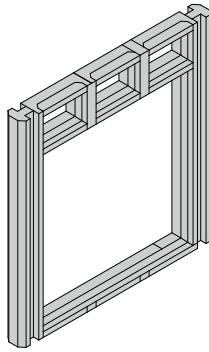

2x

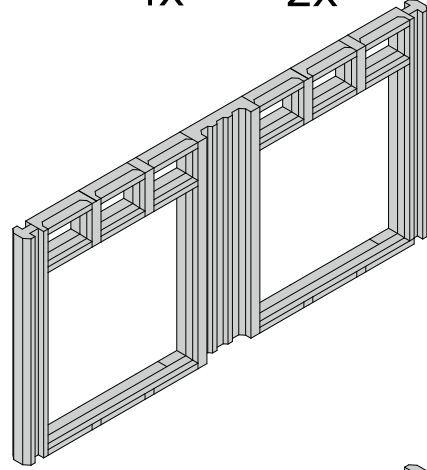

2x

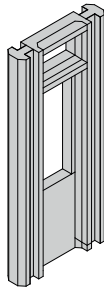

2x

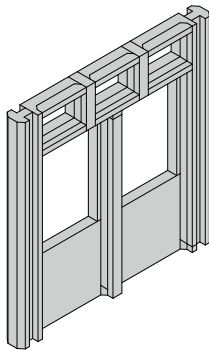

2x

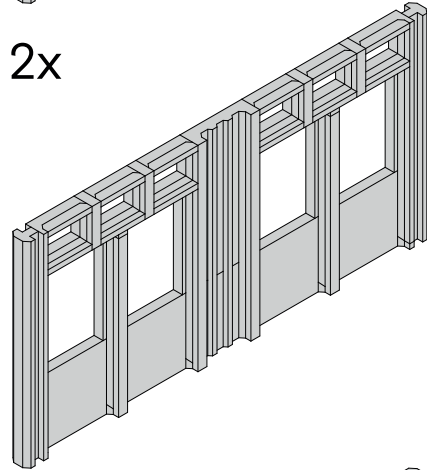

2x

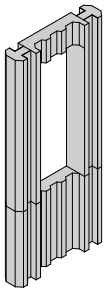

20x

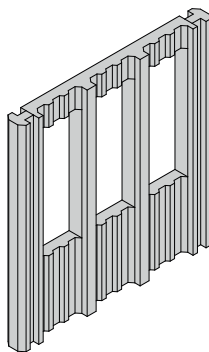

20x

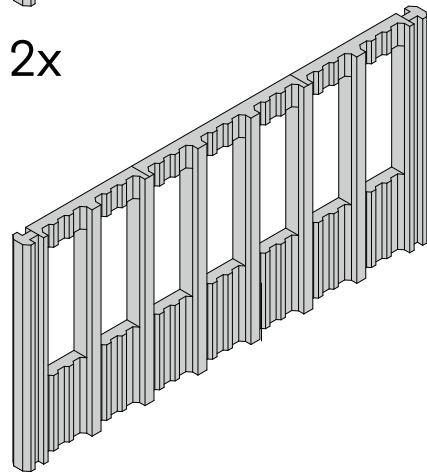

20x

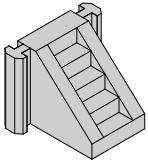

4x

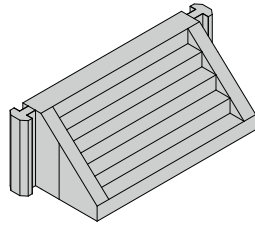

6x

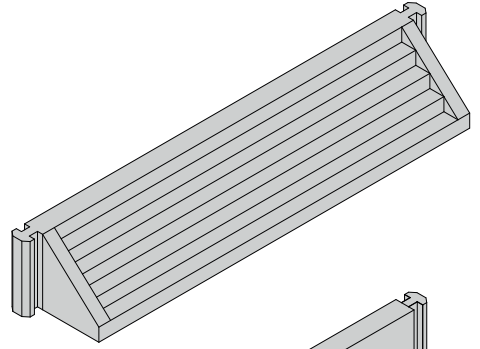

2x

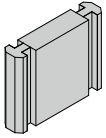

4x

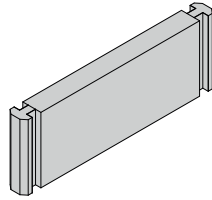

6x

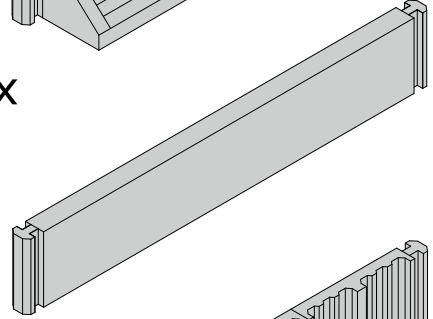

2x

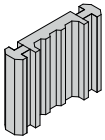

12x

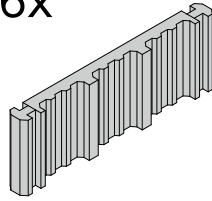

12x

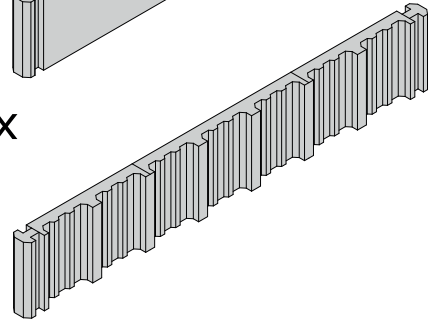

12x

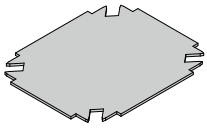

15x

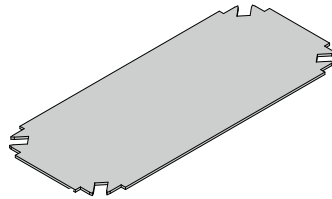

15x

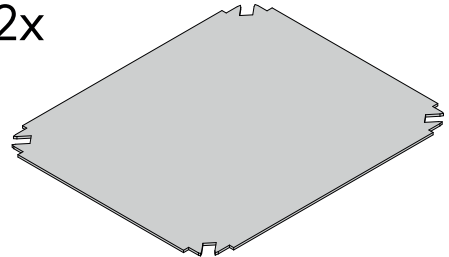

15x

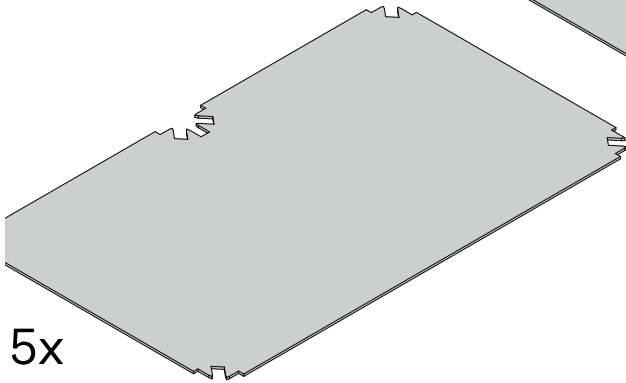

5x

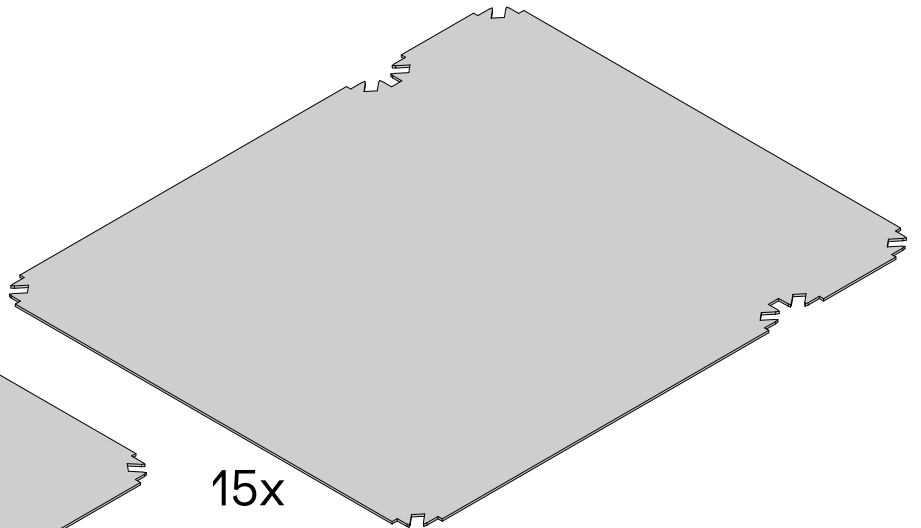

15x

1

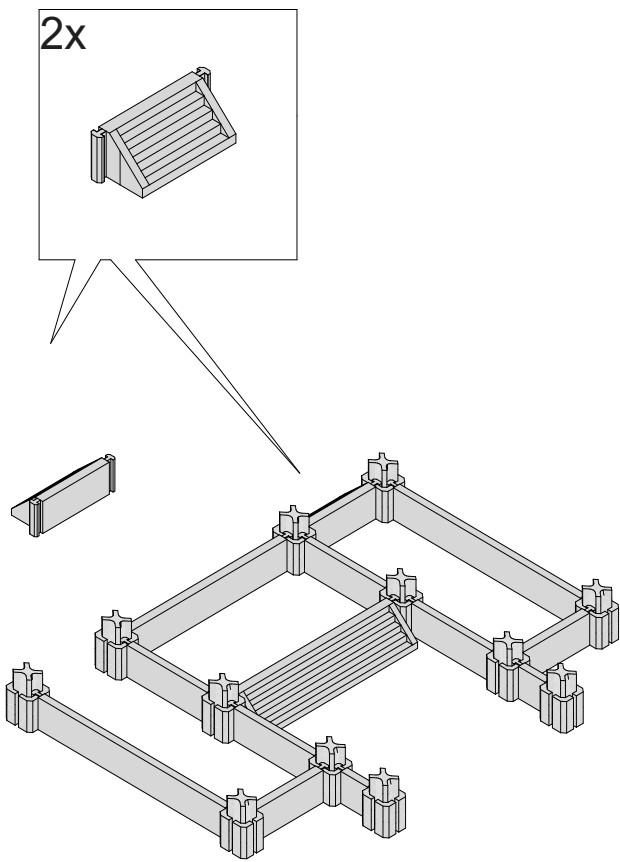

2

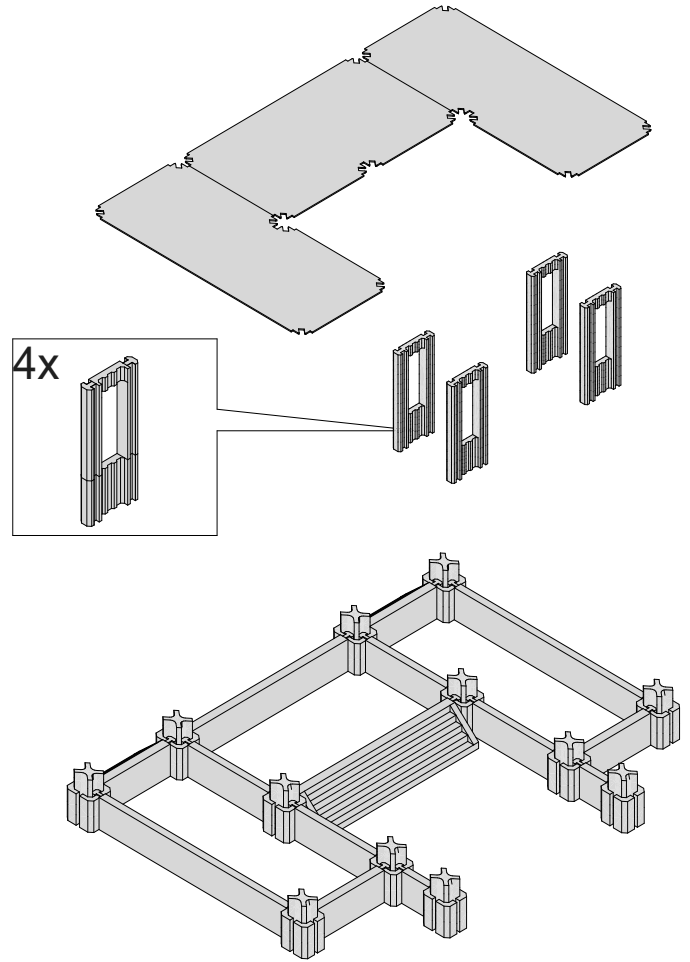

3

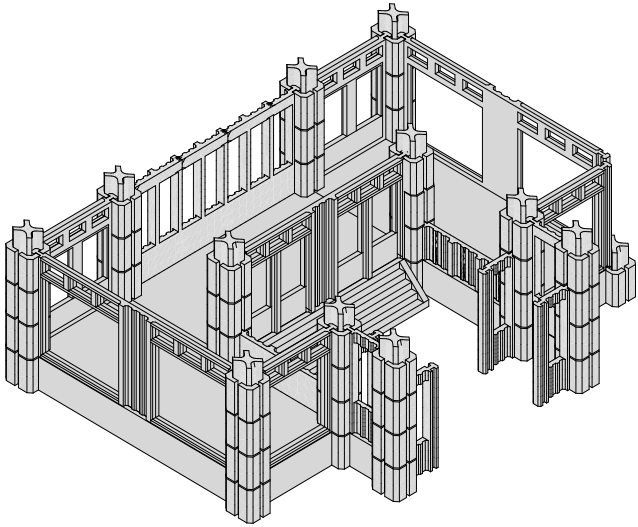
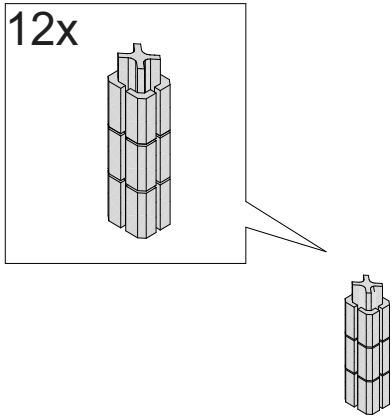

4

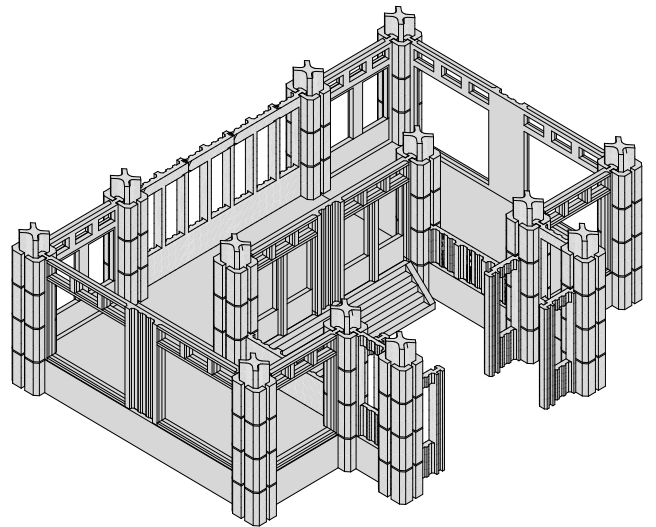
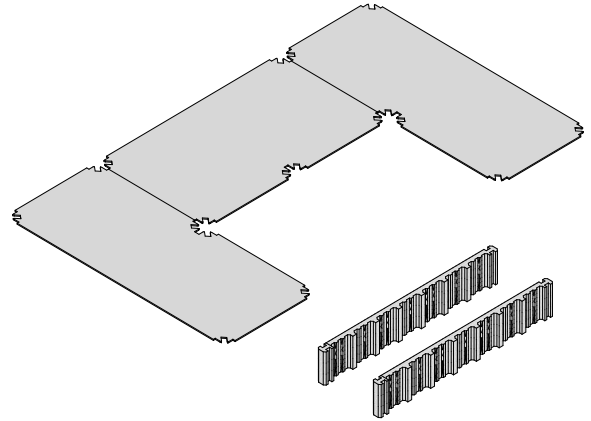

5

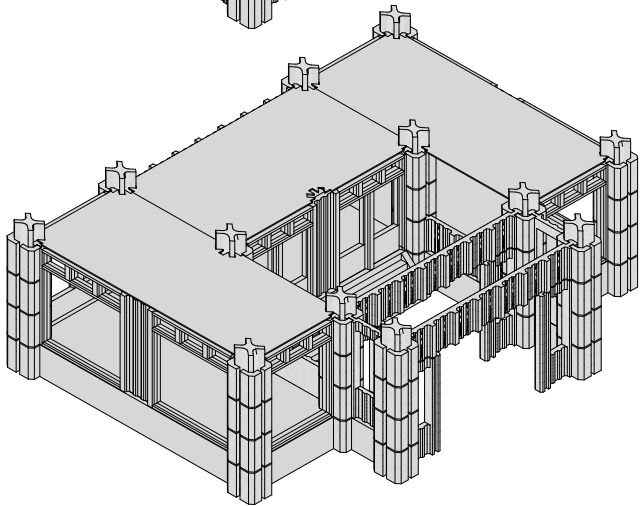
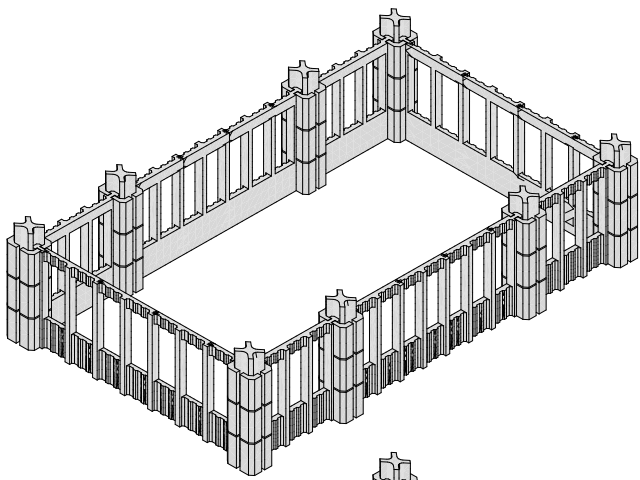
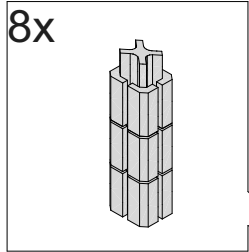

6

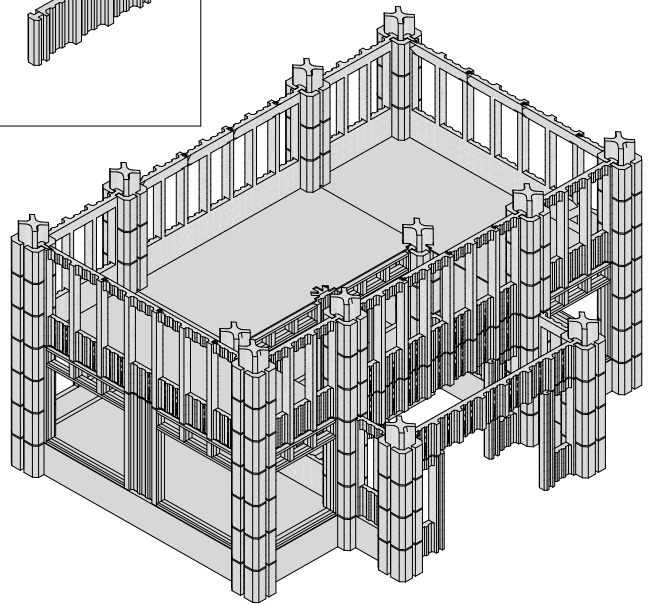
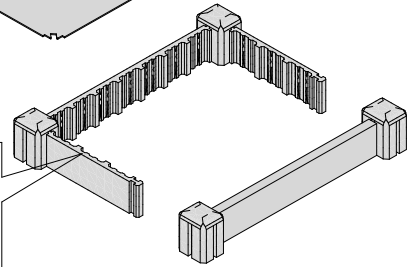
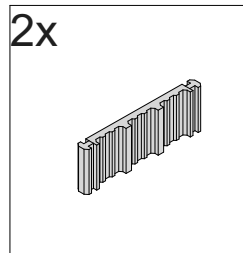
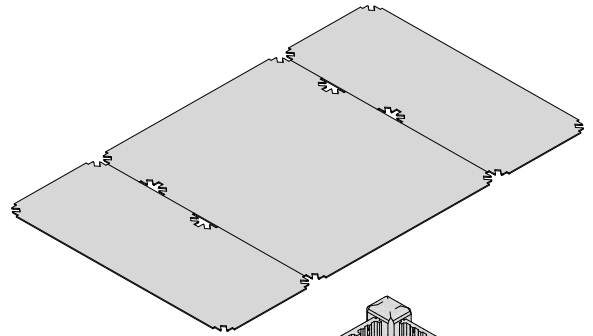

7

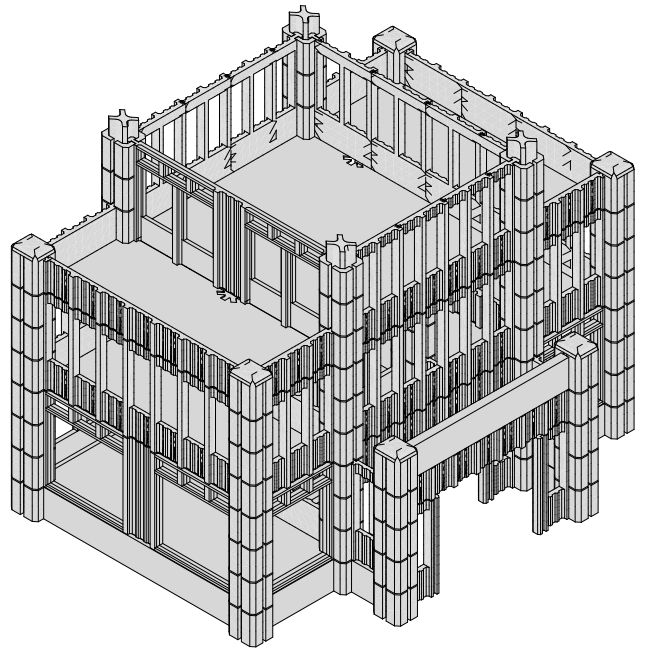
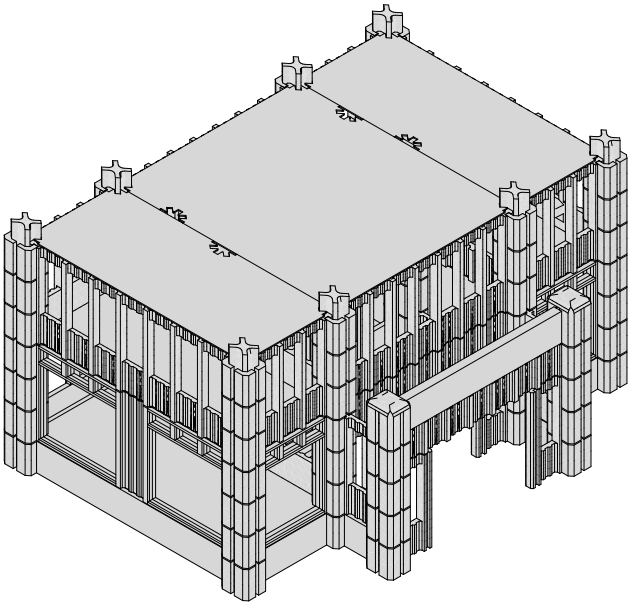
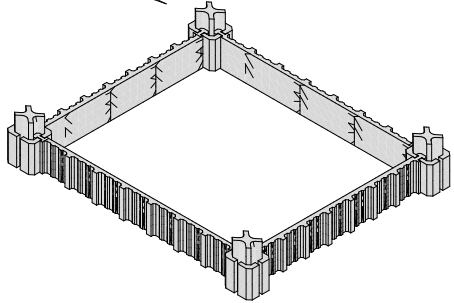
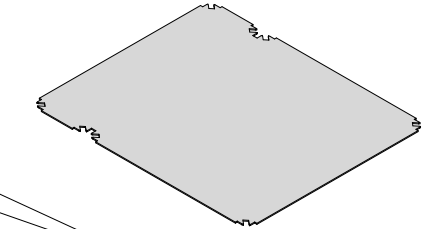
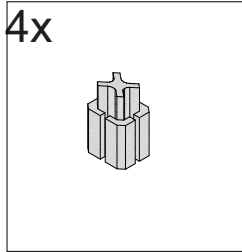
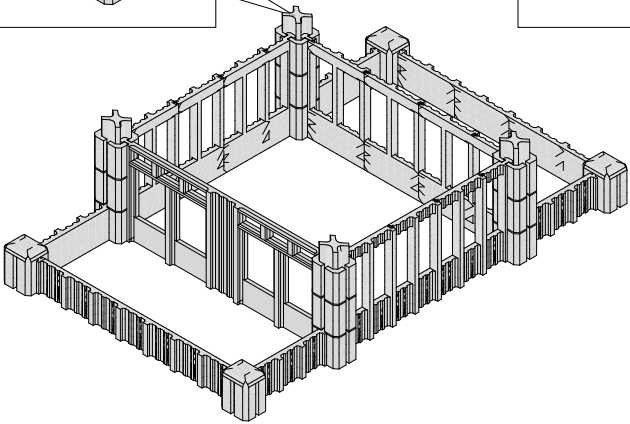
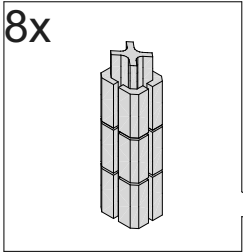

8

2x

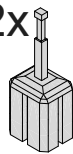

2x

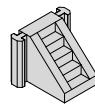

2x

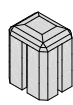

10x

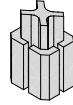

9

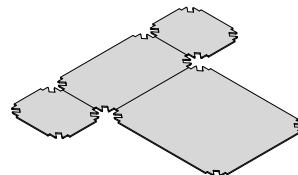

10

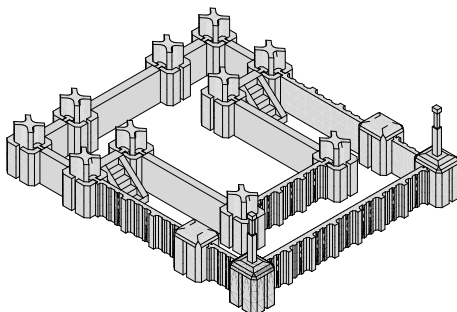

3x

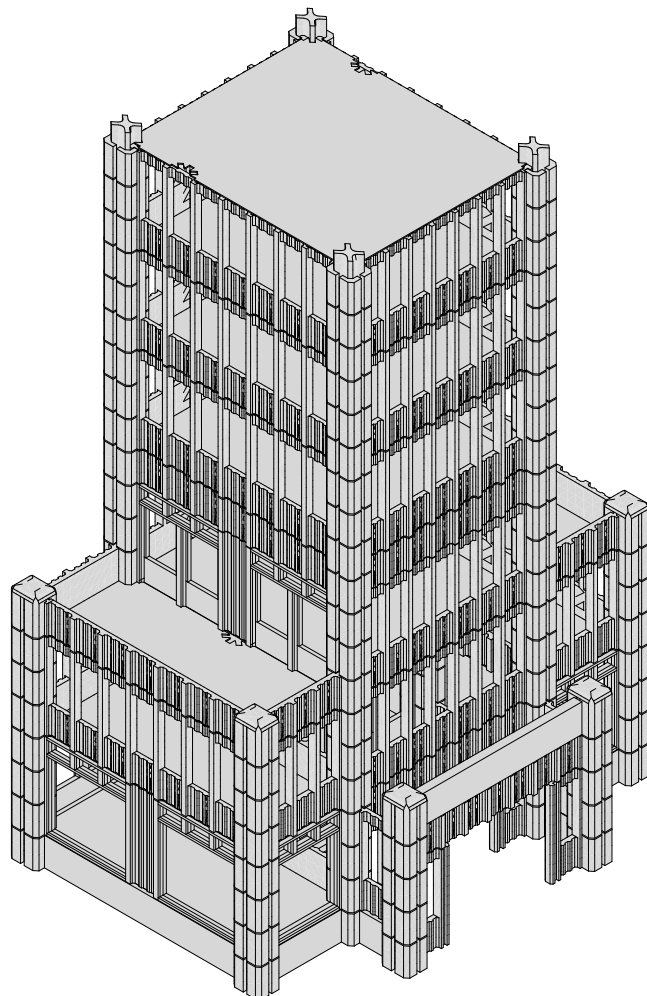
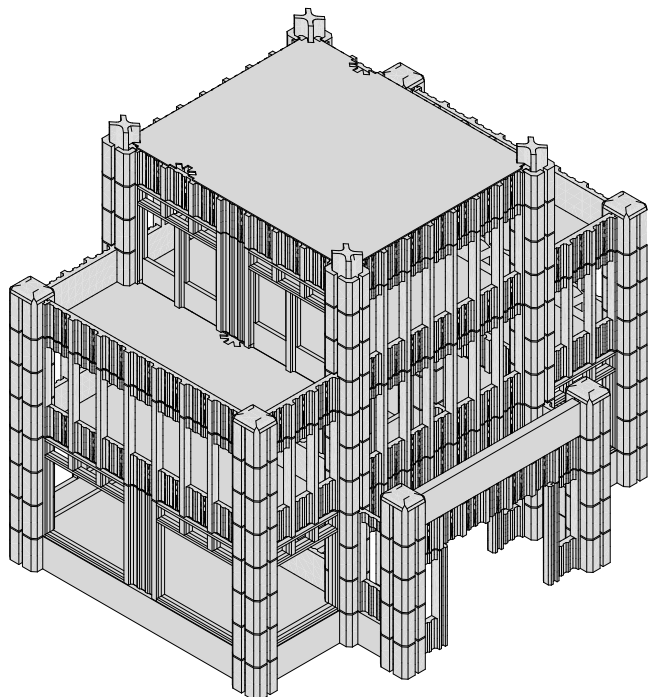
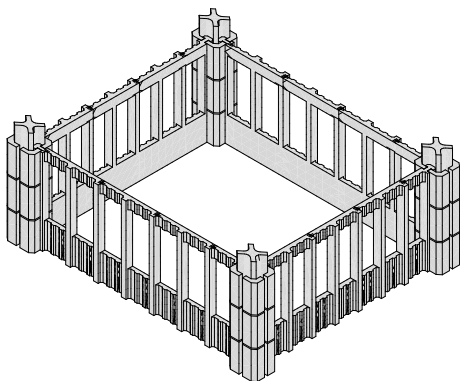
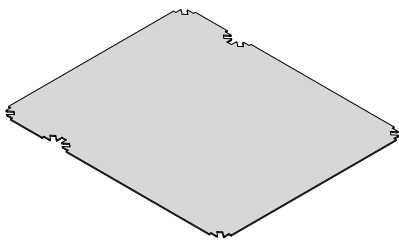

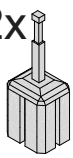
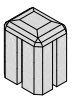
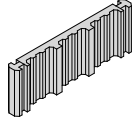
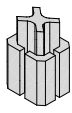
- 2x

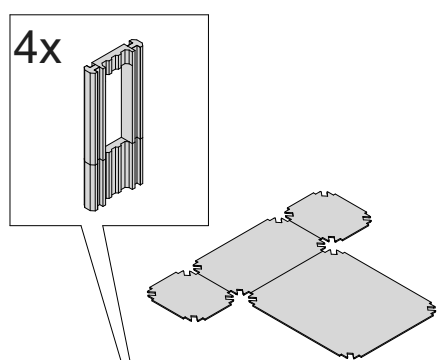
- 4x

- 1x

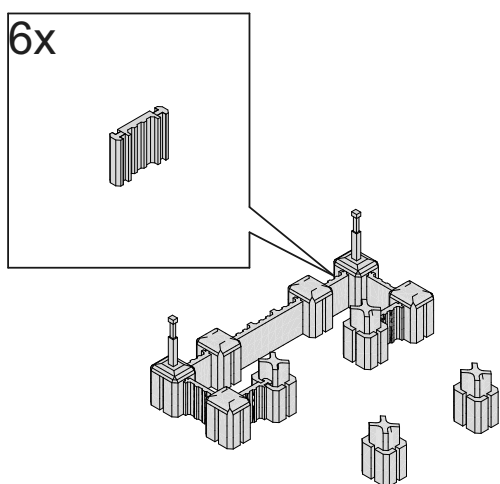
- 4x

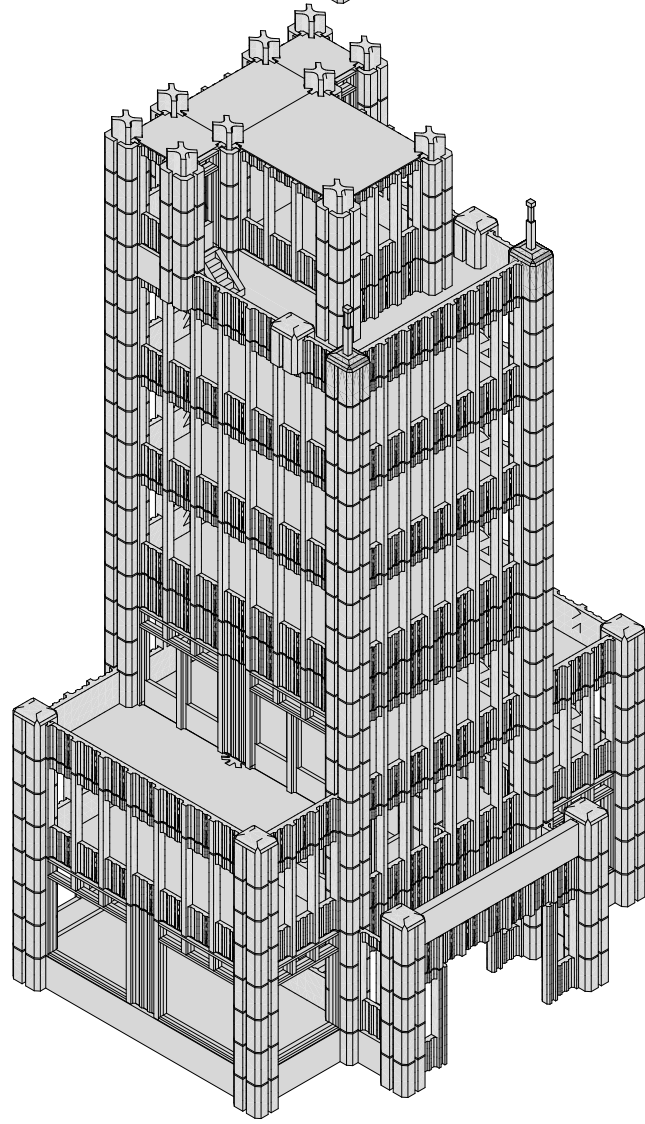
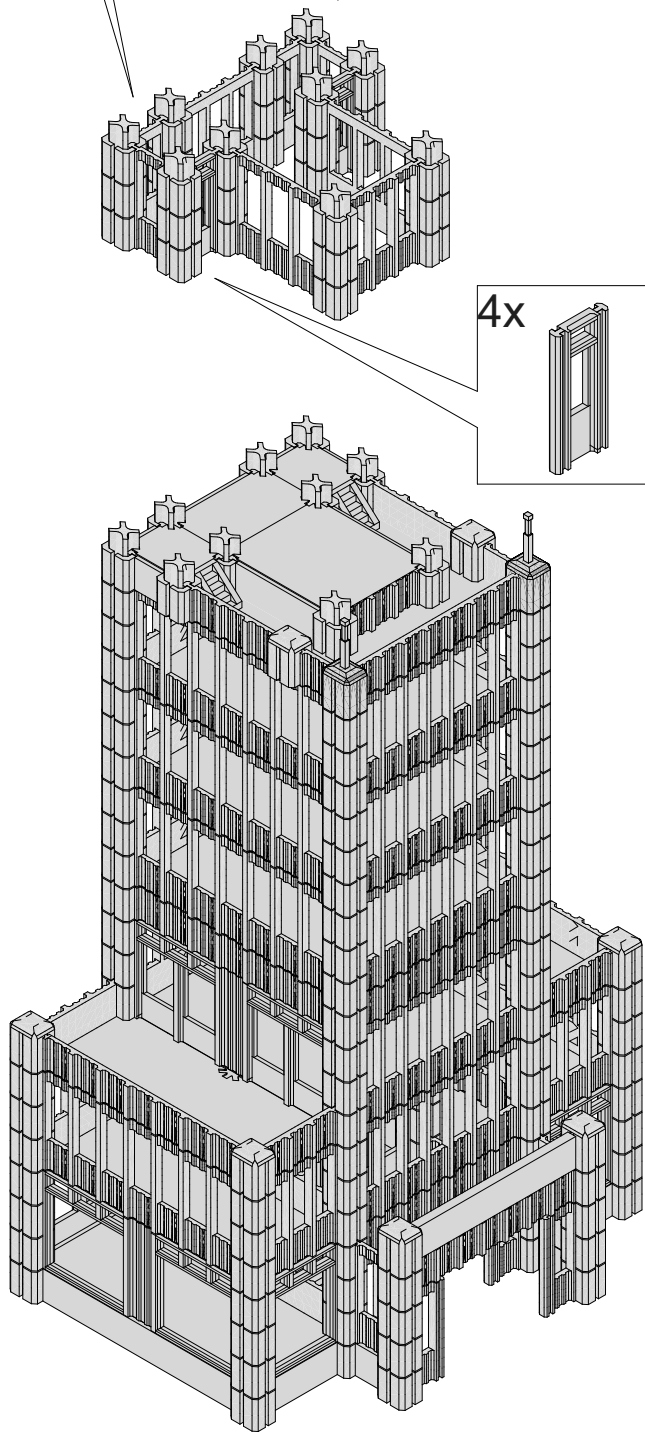

11



12



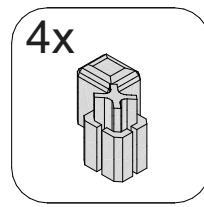
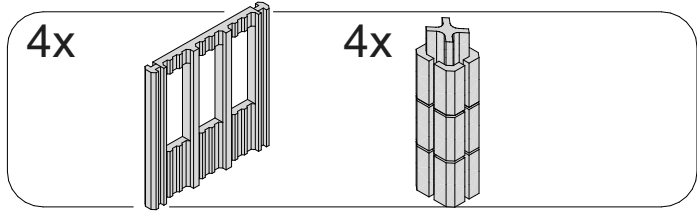

13

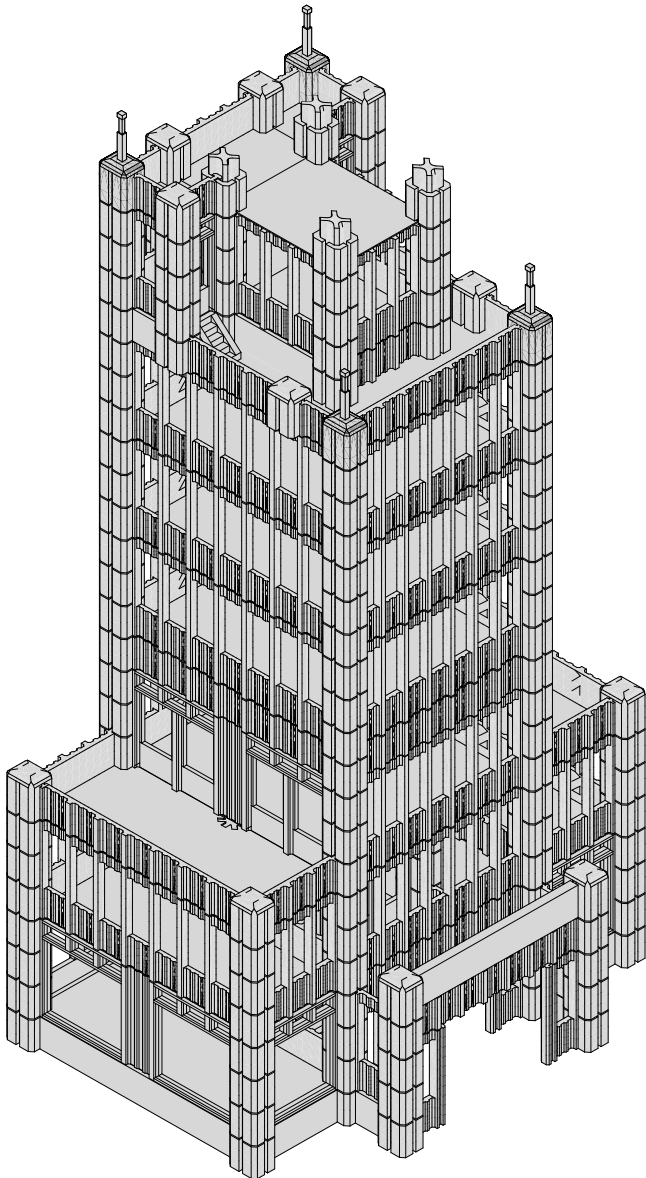
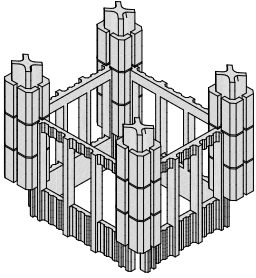
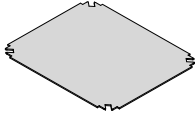

14

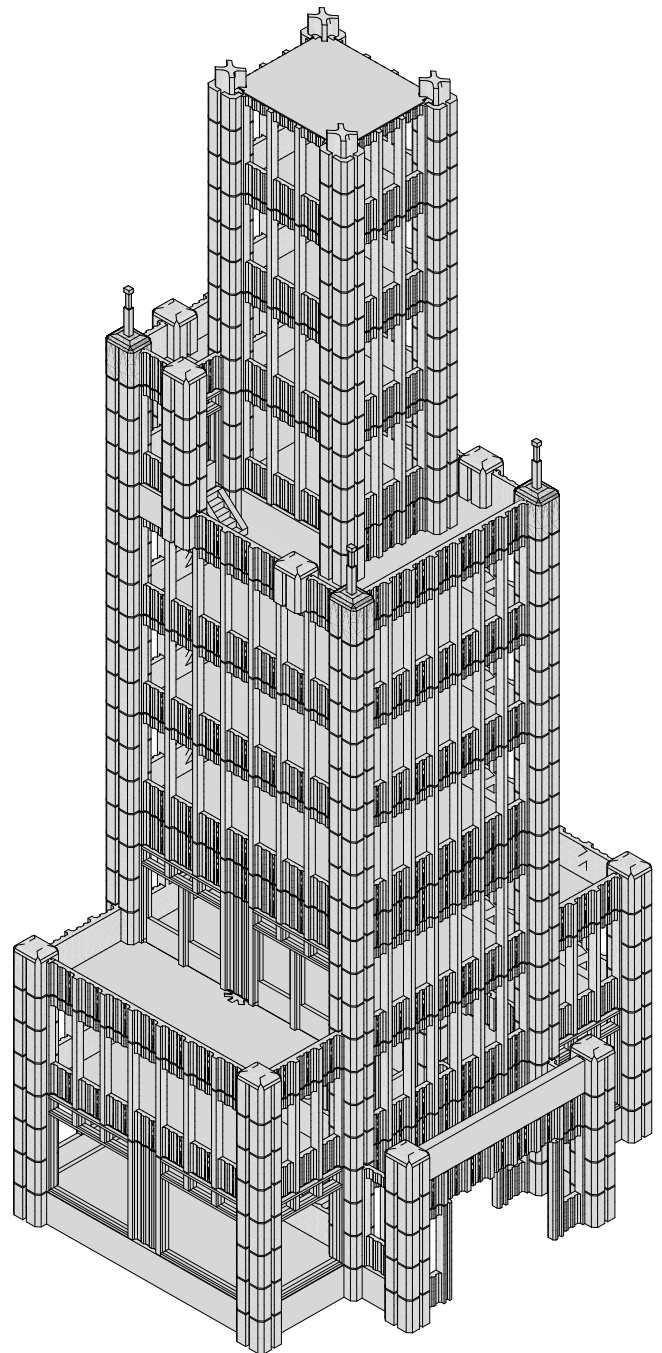
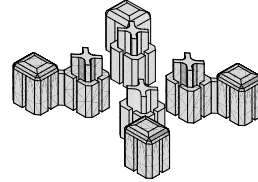

4x

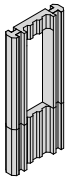

8x

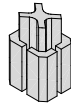

15

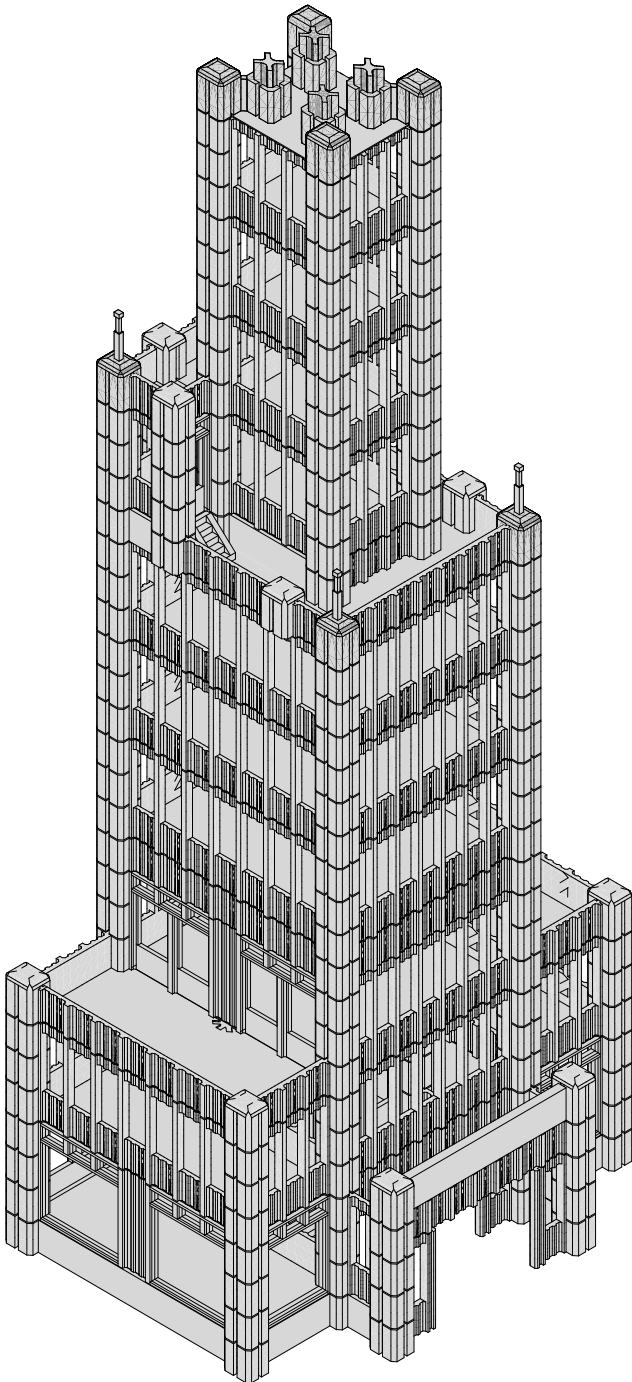
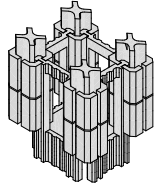

3x

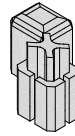

1x

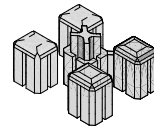

16

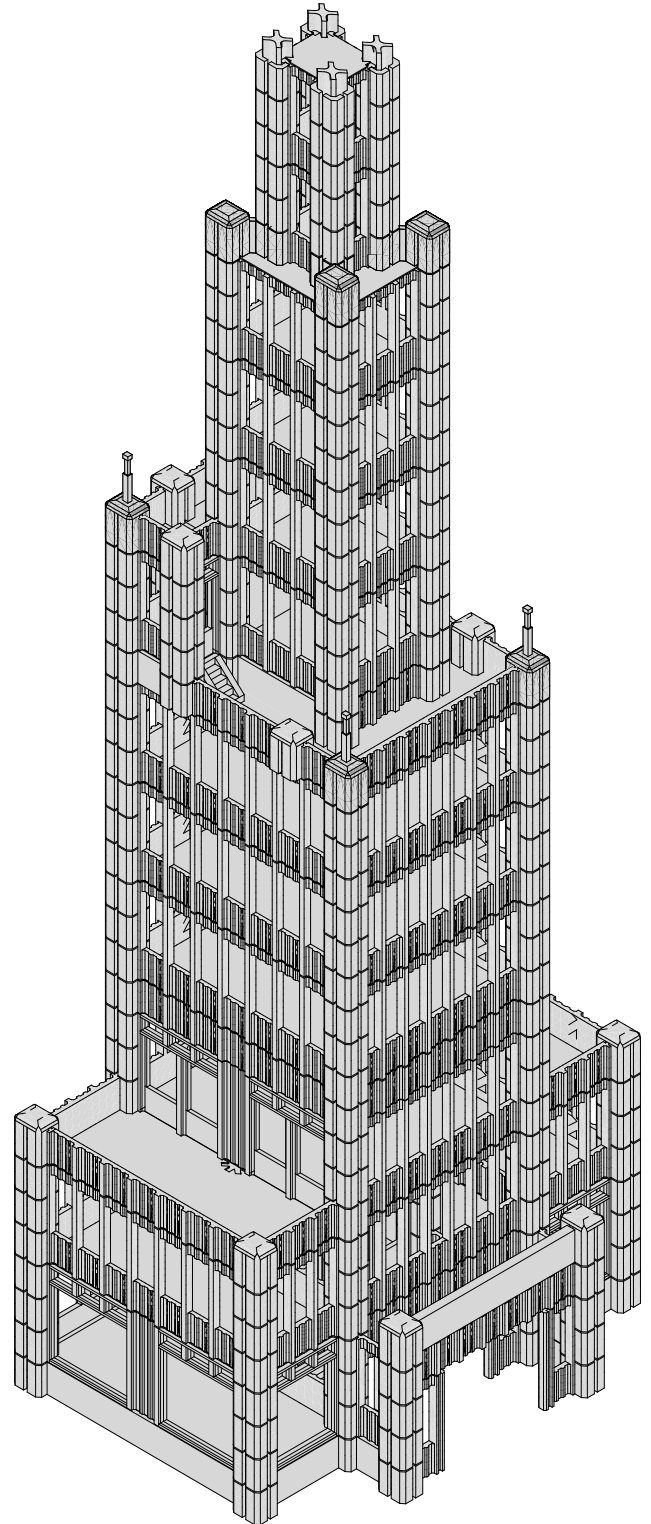

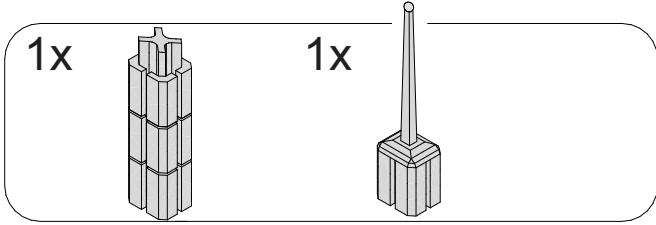

17

