

INGENIUS

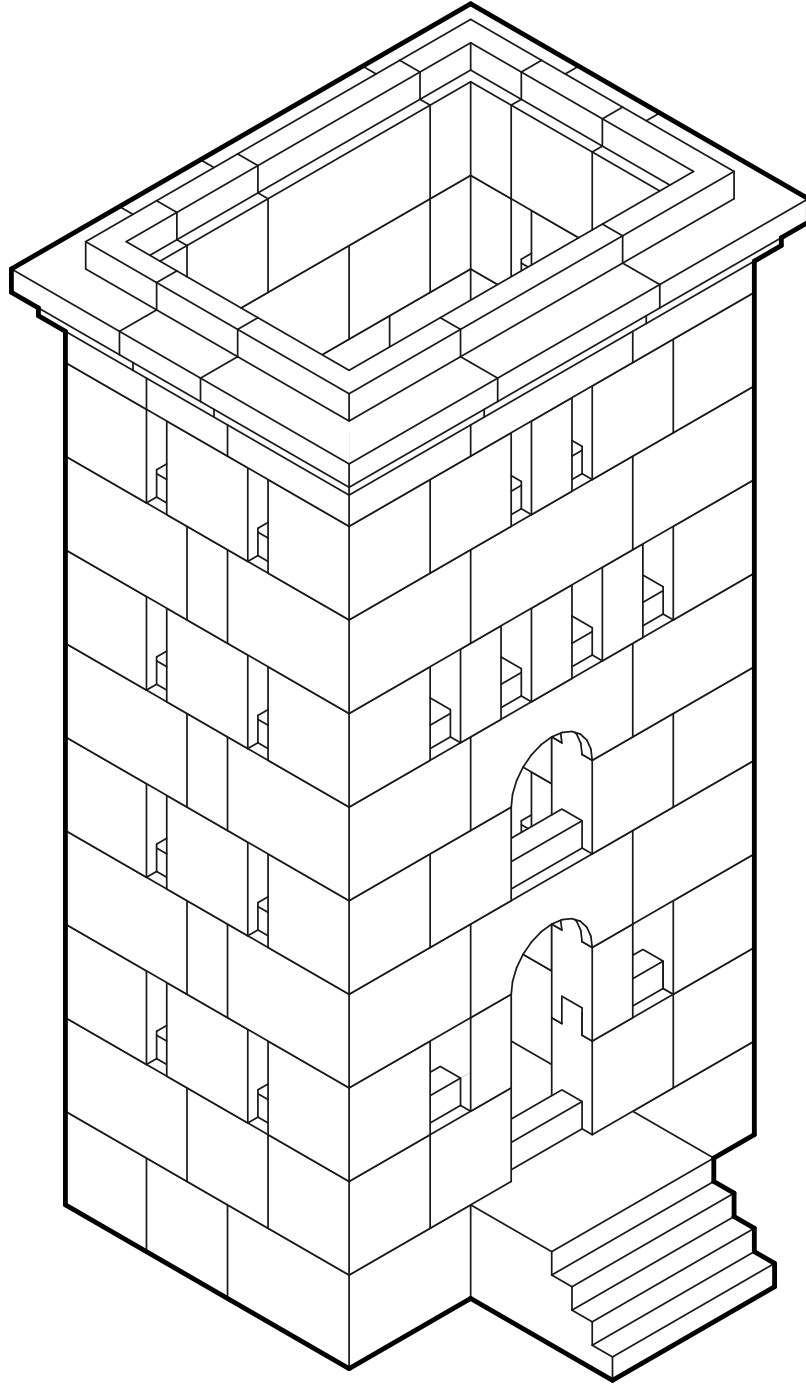

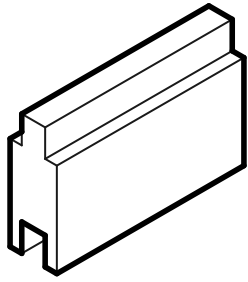

10x

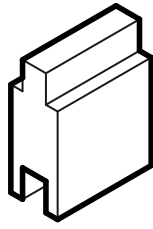

23x

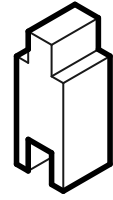

12x

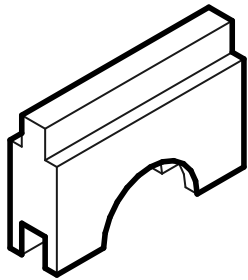

2x

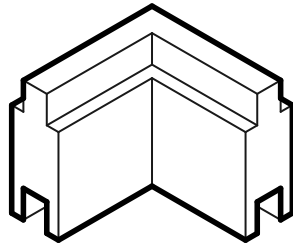

16x

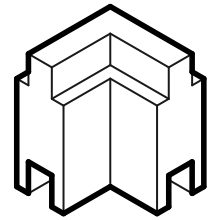

20x

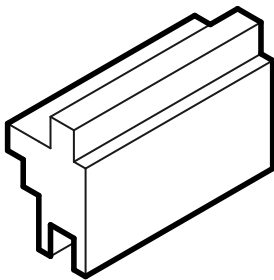

2x

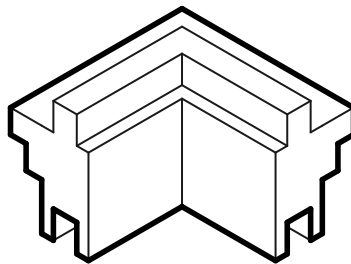

2x

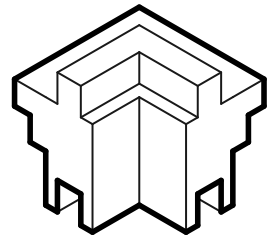

2x

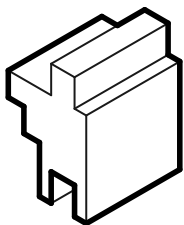

3x

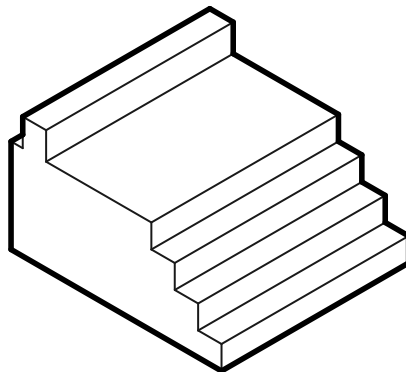

1x

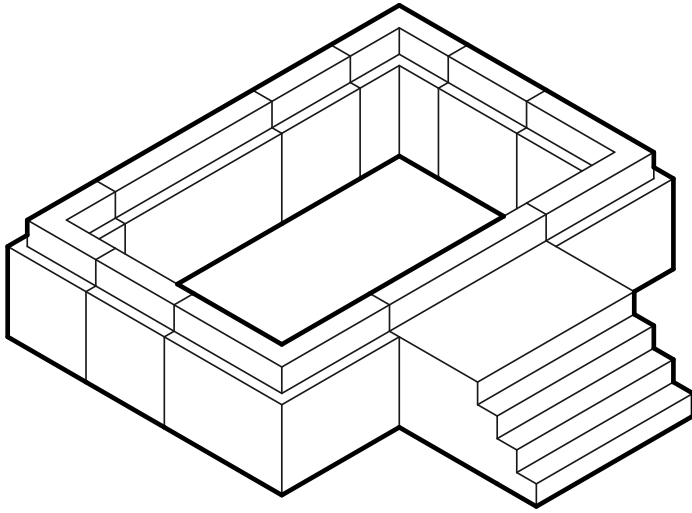

1

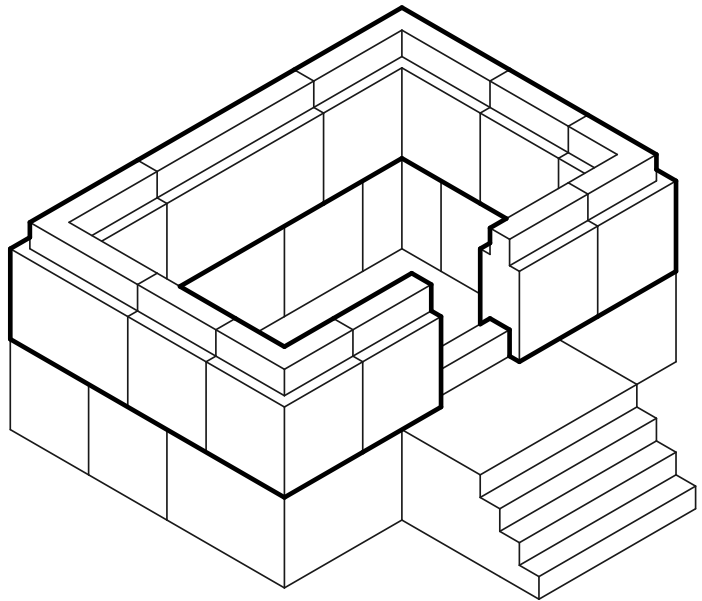

2

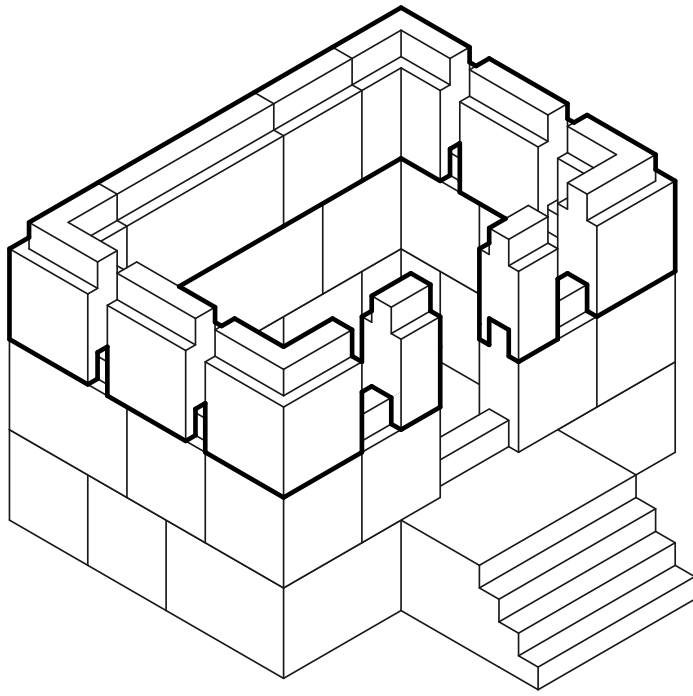

3

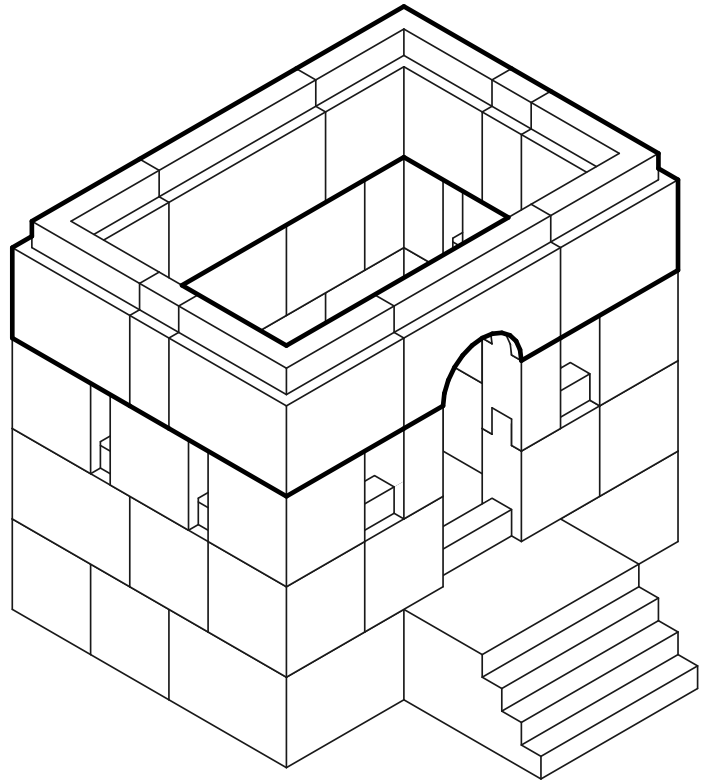

4

5

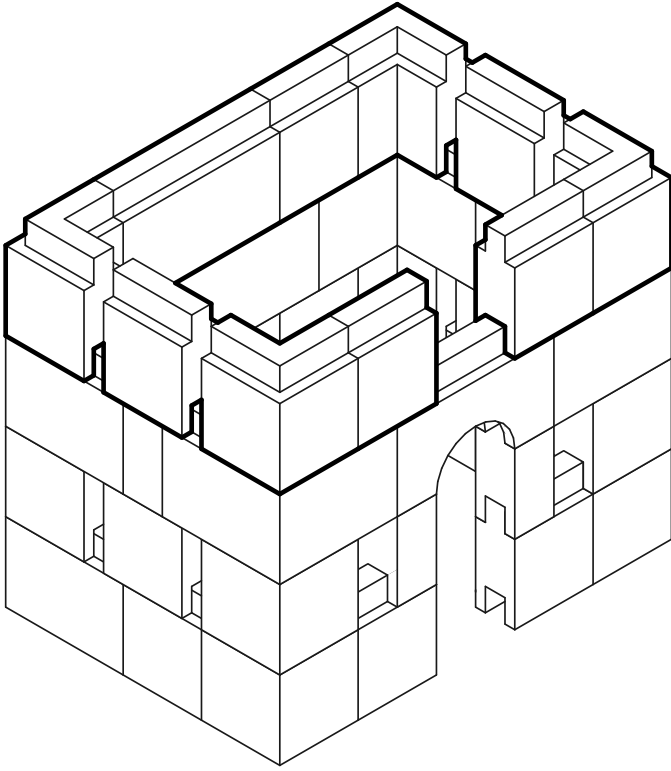

6

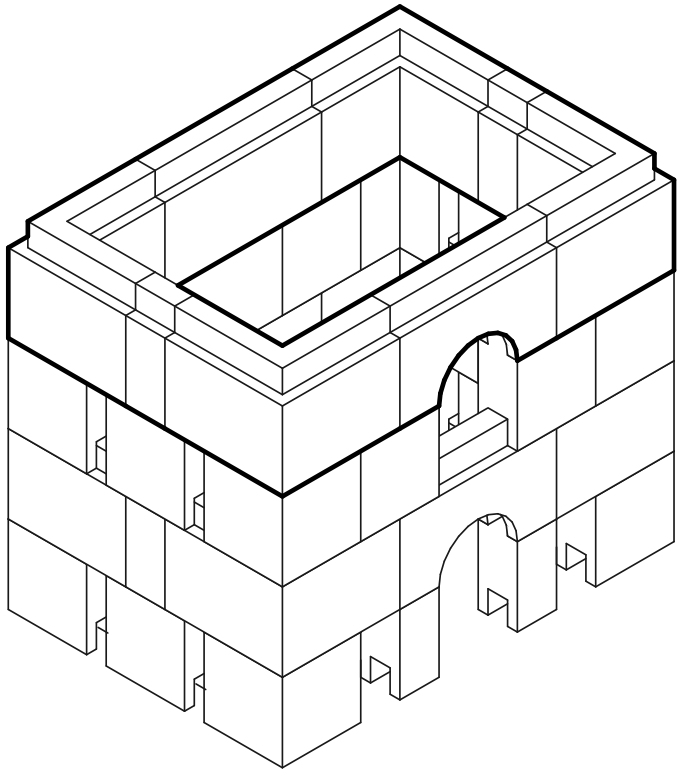

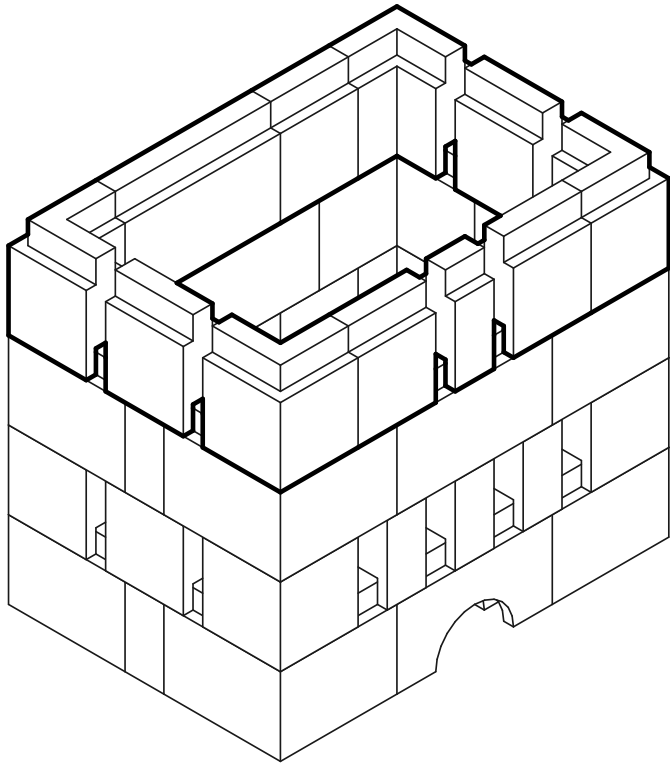

7

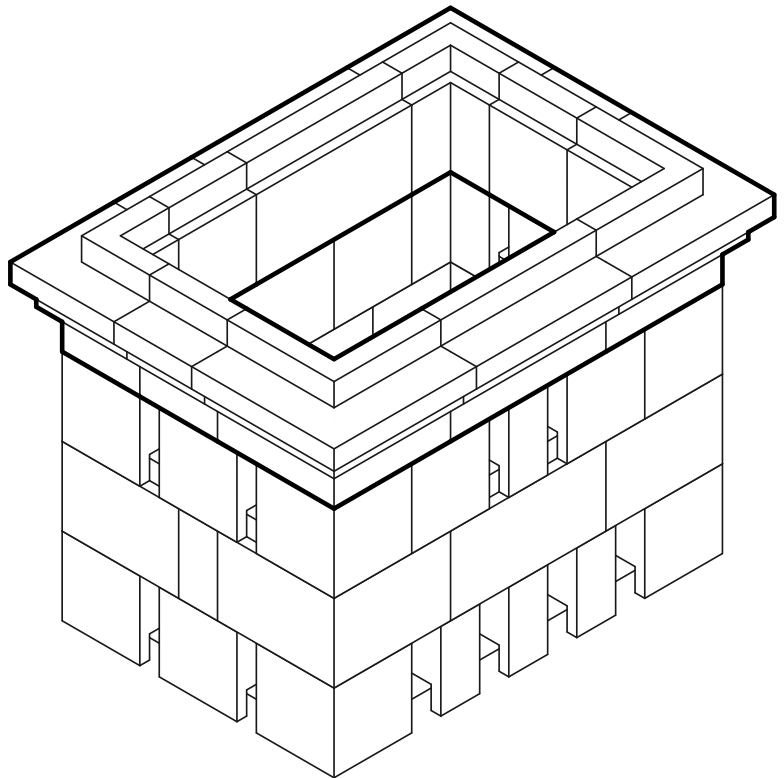

8

